



SAN PU SEMICONDUCTOR

SPS E13007-2

HIGH VOLTAGE POWER TRANSISTOR

FEATURES: High Voltage Capability
High Speed Switching
Wide SOA

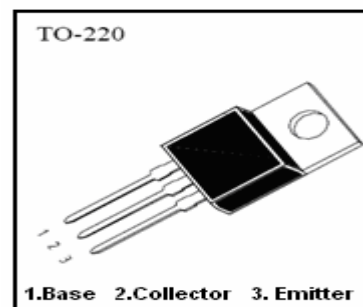
APPLICATIONS: Flourscent Lamp
Electronic Ballast
Electronic Transformer



LIMITING VALUES ($T_j=25^\circ\text{C}$ Unless Otherwise Stated)

Parameter	Symbol	Value	Unit
Collector-Base Voltage	V_{CB0}	700	V
Collector-Emitter Voltage	V_{CE0}	400	V
Emitter-Base Voltage	V_{EB0}	9	V
Collector Current	I_c	8	A
Total Power Dissipation	P_c	80	W
Storage Temperature	T_{stg}	-65~150	$^\circ\text{C}$
Junction Temperature	T_j	150	$^\circ\text{C}$

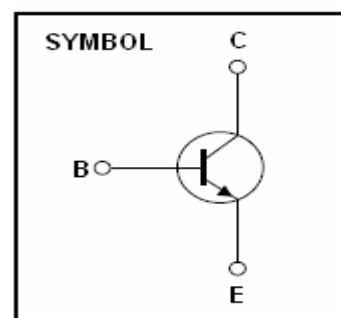

ELECTRICAL CHARACTERISTICS ($T_j=25^\circ\text{C}$ Unless Otherwise Stated)

Parameter	Symbol	Test conditions	Min	Max	Unit
Collector-Base Breakdown Voltage	BV_{CB0}	$I_c=0.5\text{mA}, I_e=0$	700		V
Collector-Emitter Breakdown Voltage	BV_{CE0}	$I_c=10\text{mA}, I_b=0$	400		V
Emitter-Base Breakdown Voltage	BV_{EB0}	$I_e=1\text{mA}, I_c=0$	9		V
Collector-Base Cutoff Current	I_{CB0}	$V_{cb}=650\text{V}, I_e=0$		10	μA
Collector-Emitter Cutoff Current	I_{CE0}	$V_{ce}=400\text{V}, I_b=0$		20	μA
Emitter-Base Cutoff Current	I_{EB0}	$V_{eb}=9\text{V}, I_c=0$		20	μA
DC Current Gain	$hFE(1)$	$V_{ce}=5\text{V}, I_c=2\text{A}$	10	40	
DC Current Gain	$hFE(2)$	$V_{ce}=5\text{V}, I_c=1\text{mA}$	9		
Collector-Emitter Saturation Voltage	$V_{CE(sat)}$	$I_c=2.0\text{A}, I_b=0.4\text{A}$		0.7	V
		$I_c=5.0\text{A}, I_b=1.0\text{A}$		1.5	
		$I_c=8.0\text{A}, I_b=2.0\text{A}$		3.0	
Base-Emitter Saturation Voltage	$V_{BE(sat)}$	$I_c=5.0\text{A}, I_b=1.0\text{A}$		1.2	V
Storage Time	T_s	$V_{cc}=250\text{V}$		4	
Falling Time	T_f	$I_c=5I_B$ $I_{B1}=-I_{B2}=1\text{A}$		0.8	μS



SPS E13007-2

HIGH VOLTAGE POWER TRANSISTOR

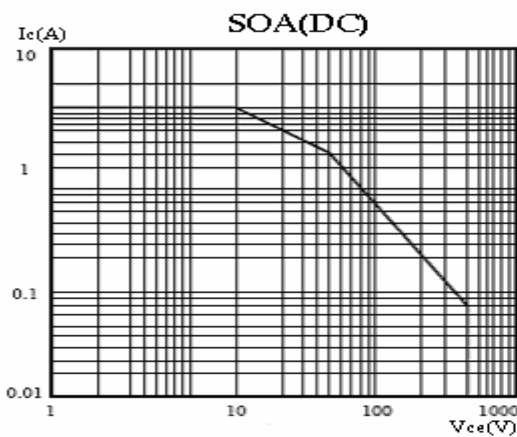
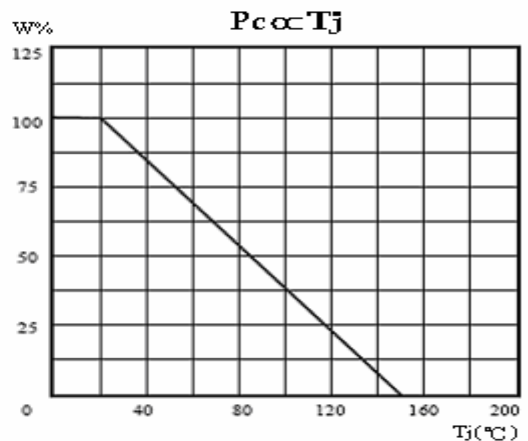
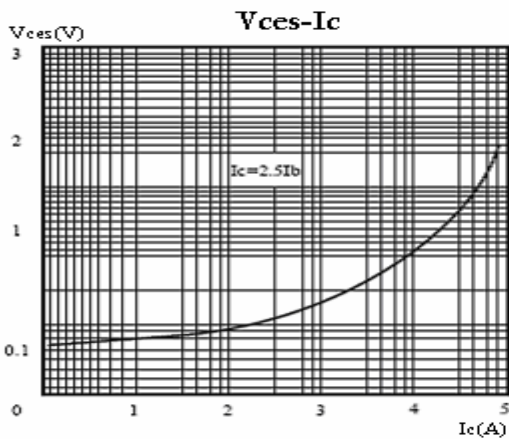
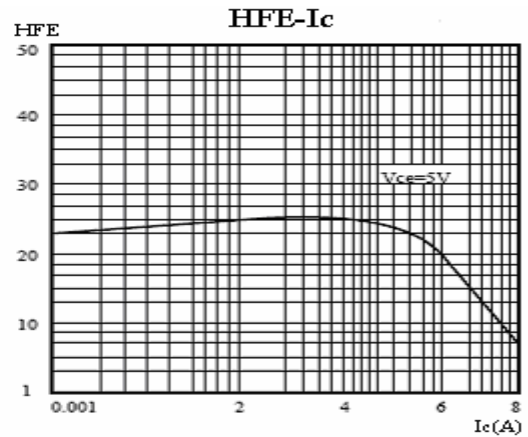
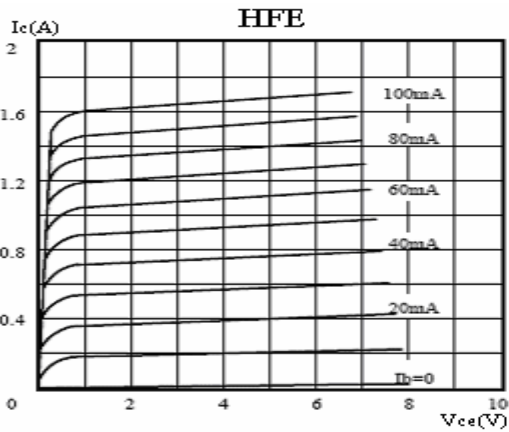



SAN PU SEMICONDUCTOR

SPS E13007-2

HIGH VOLTAGE POWER TRANSISTOR

TO-220 MECHANICAL DATA

UNIT: mm

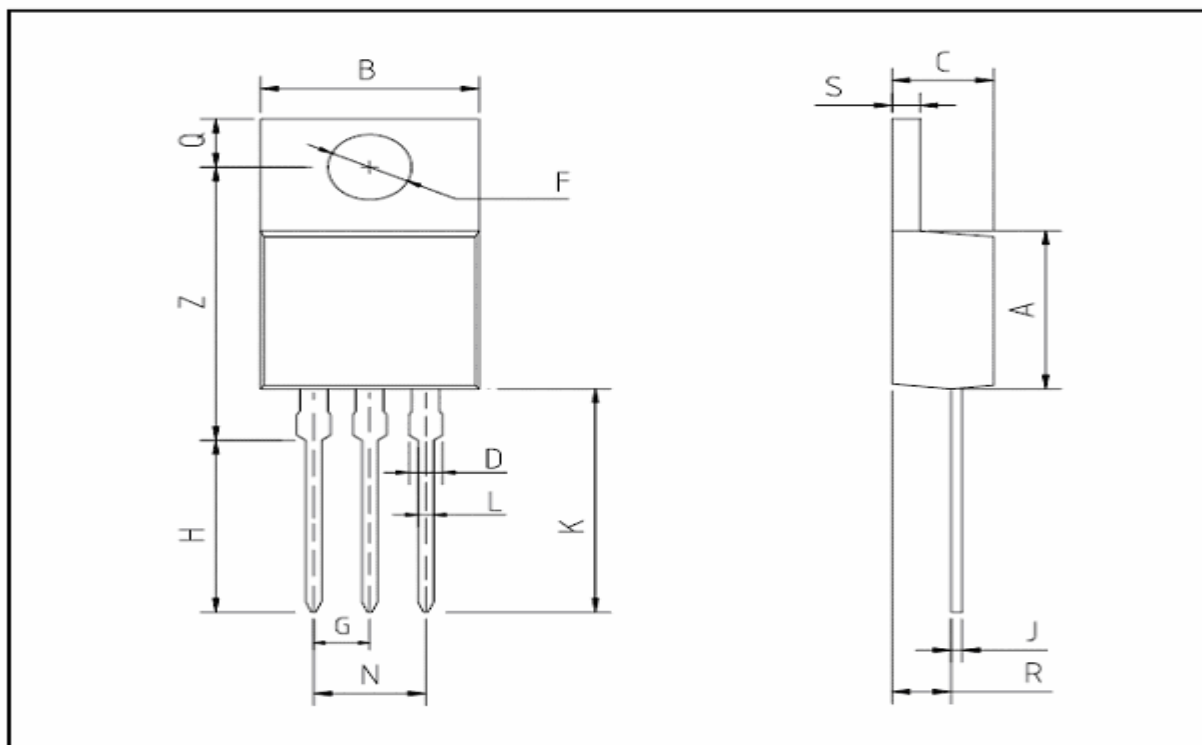

SYMBOL	Min	Nom	Max
A	8.8	9	9.2
B	9.5	10	10.5
C	4.2	4.5	4.8
D	1.2	1.25	1.3
F	φ3.4	φ3.6	φ3.8
G		2.54	
H	9.5	10	10.5
J	0.43	0.45	0.47
K	13	13.5	14
L	0.75	0.8	0.85
N		5.08	
P			
Q	2.7	2.8	2.9
R	2.7	2.75	2.8
S	1.2	1.25	1.3
Z	15.7	15.9	16.1